

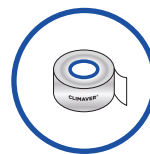

**CLIMAVER®**

*Notice de  
façonnage*

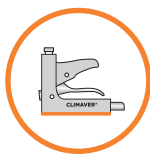

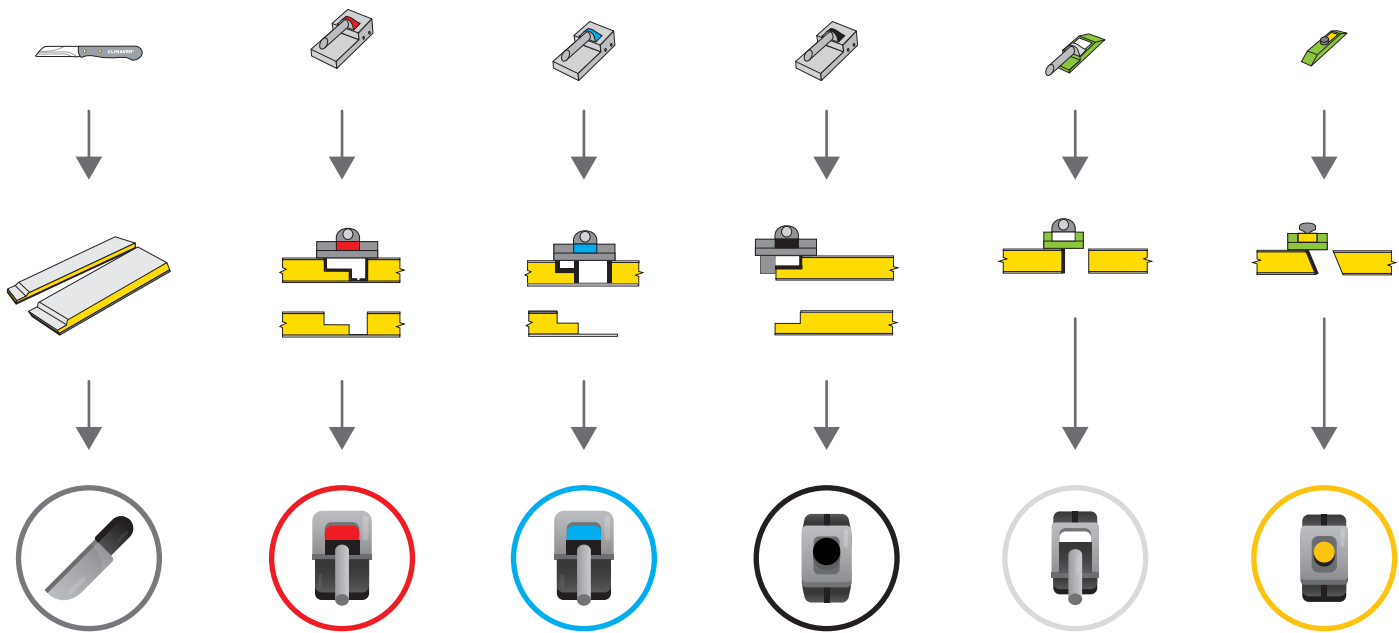

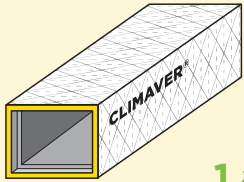

1.a

ISOVER  
SAINT-GOBAIN

CLIMAVER®



1.a

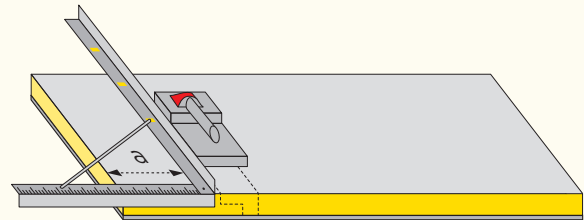
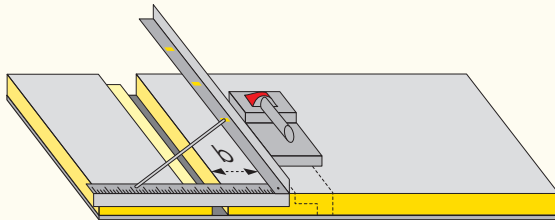
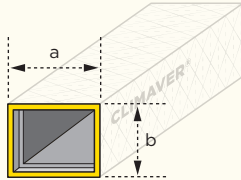

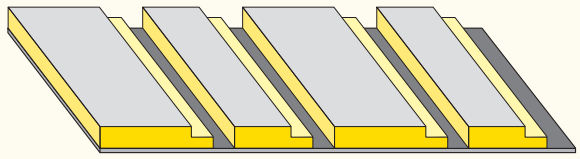
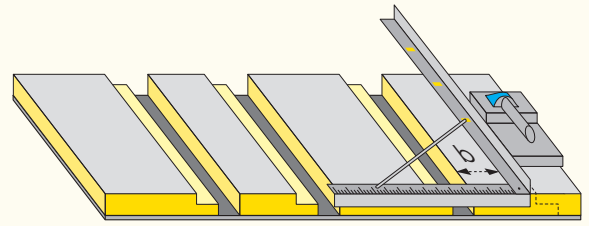
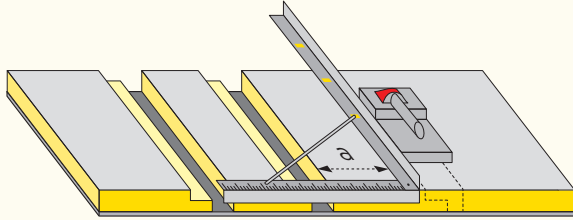

2

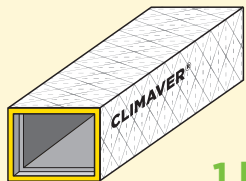

1.b

ISOVER  
SAINT-GOBAIN

CLIMAVER®



1.b

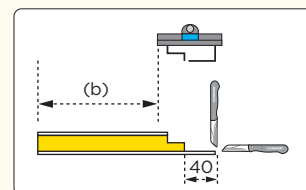
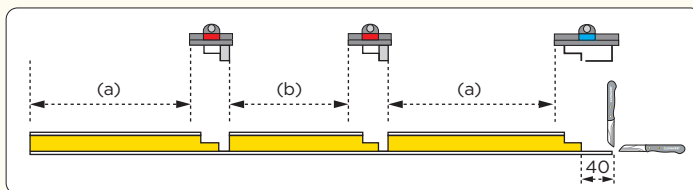
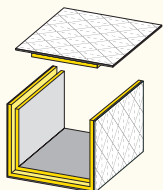
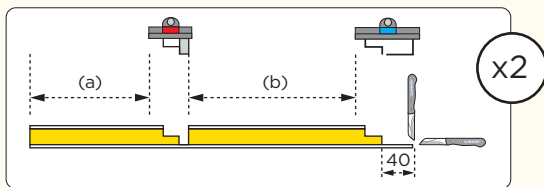
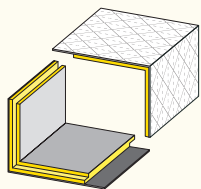
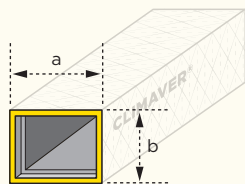

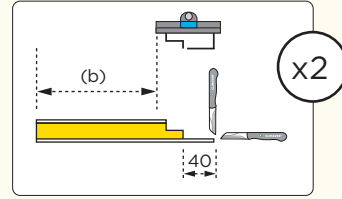
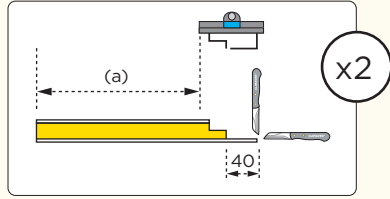
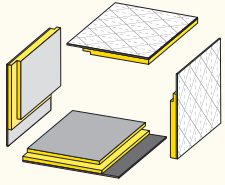

2

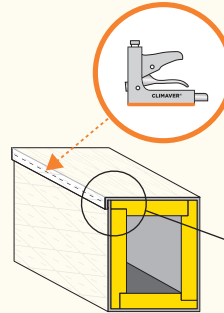
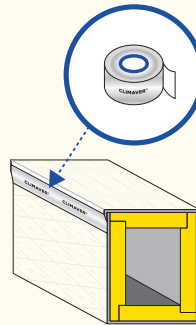
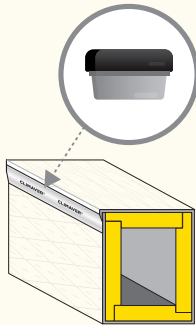
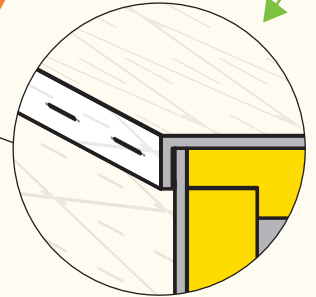
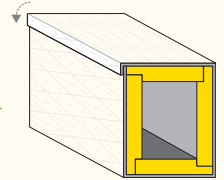
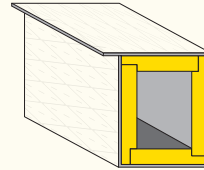
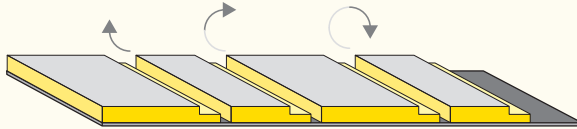

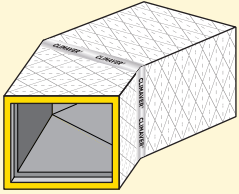

**ISOVER**  
SAINT-GOBAIN

**CLIMAVÉR®**

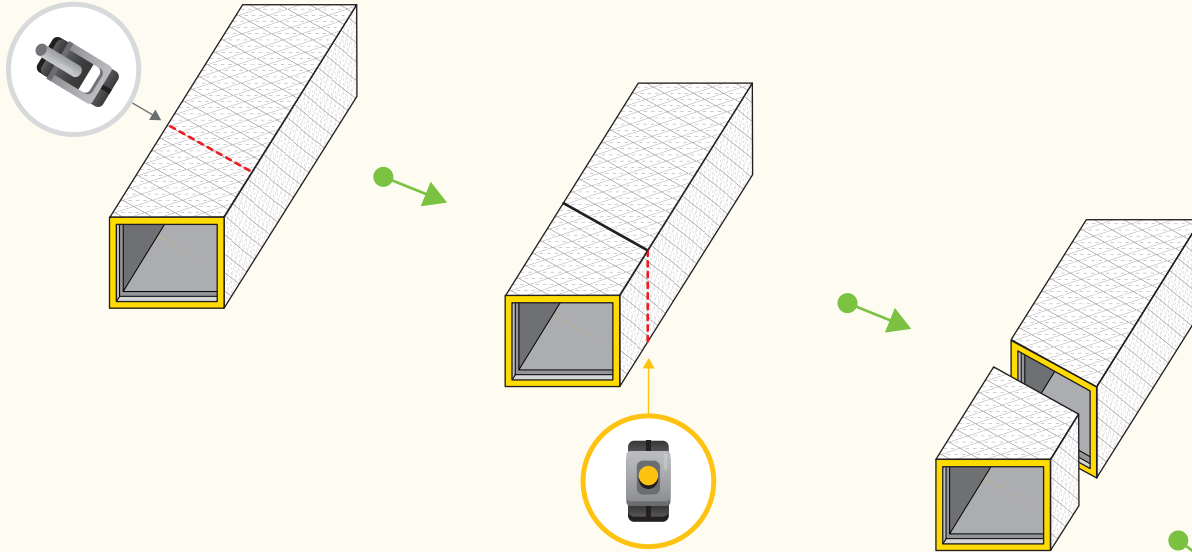

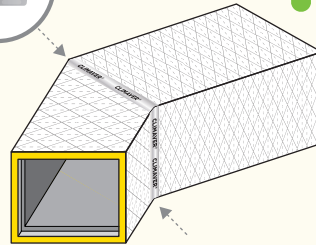
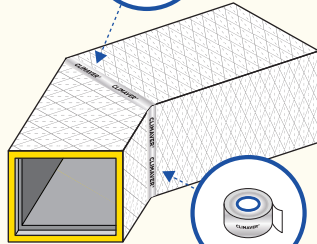
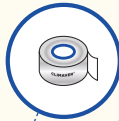
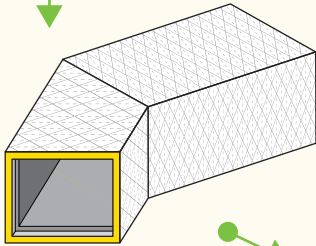
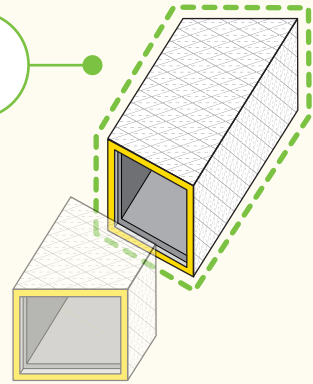
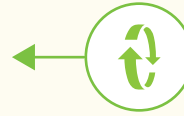
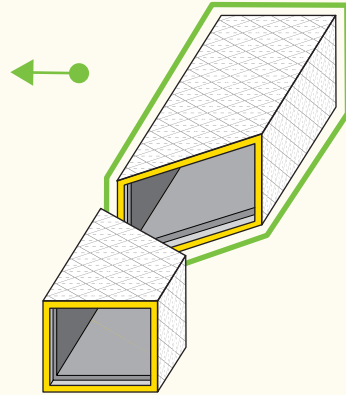
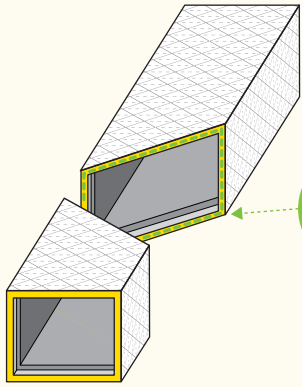

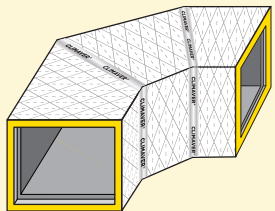

**ISOVER**  
SAINT-GOBAIN

**CLIMAVÉR®**

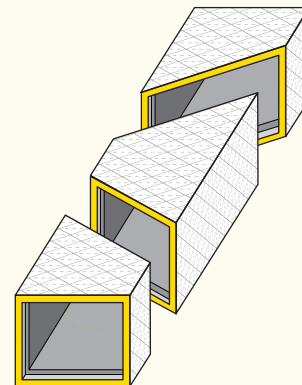
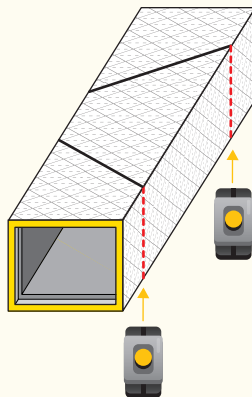
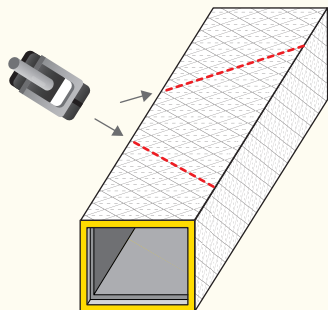

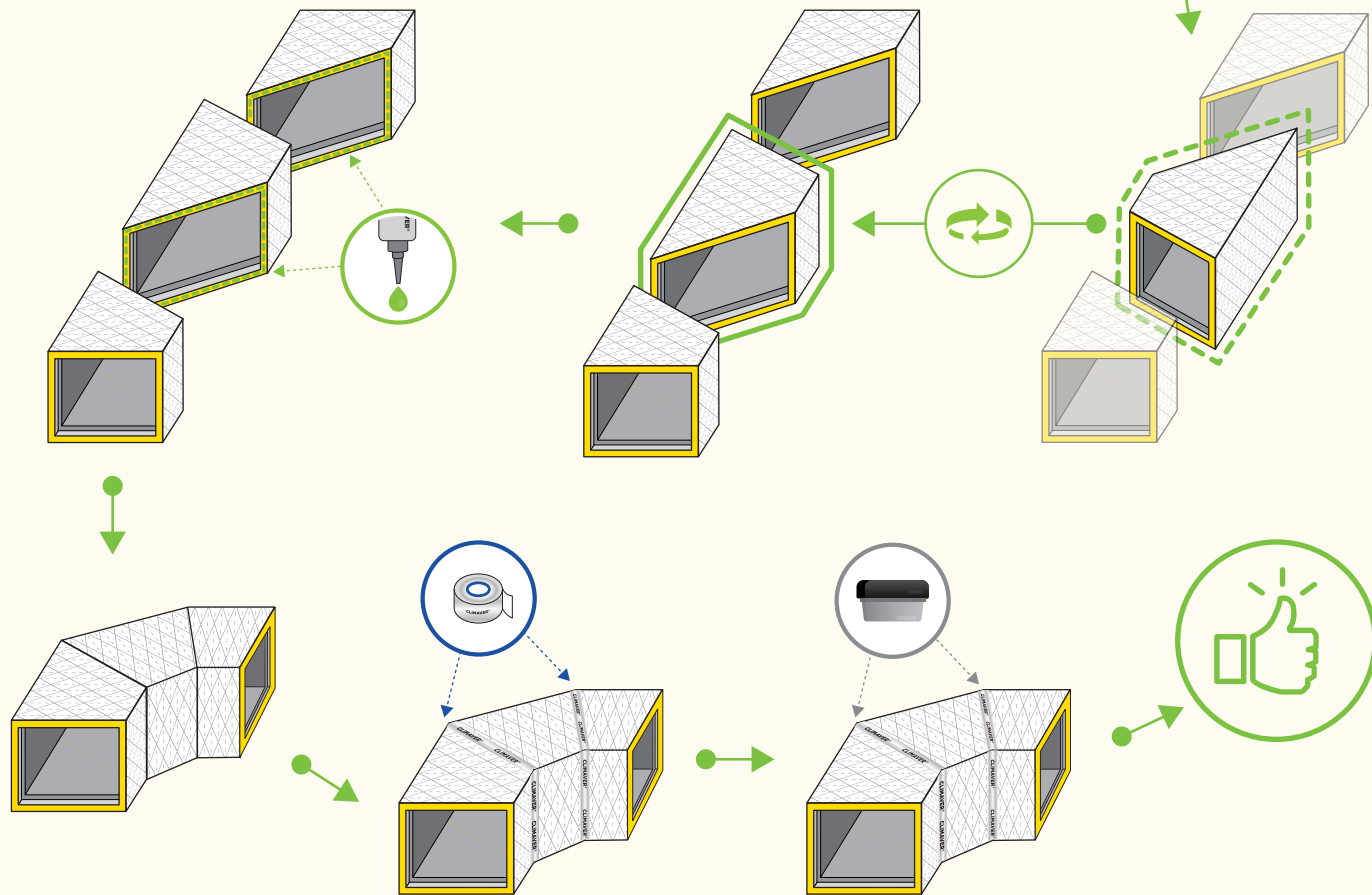

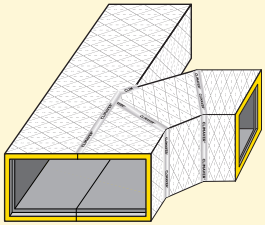

**ISOVER**  
SAINT-GOBAIN

**CLIMAVÉR®**

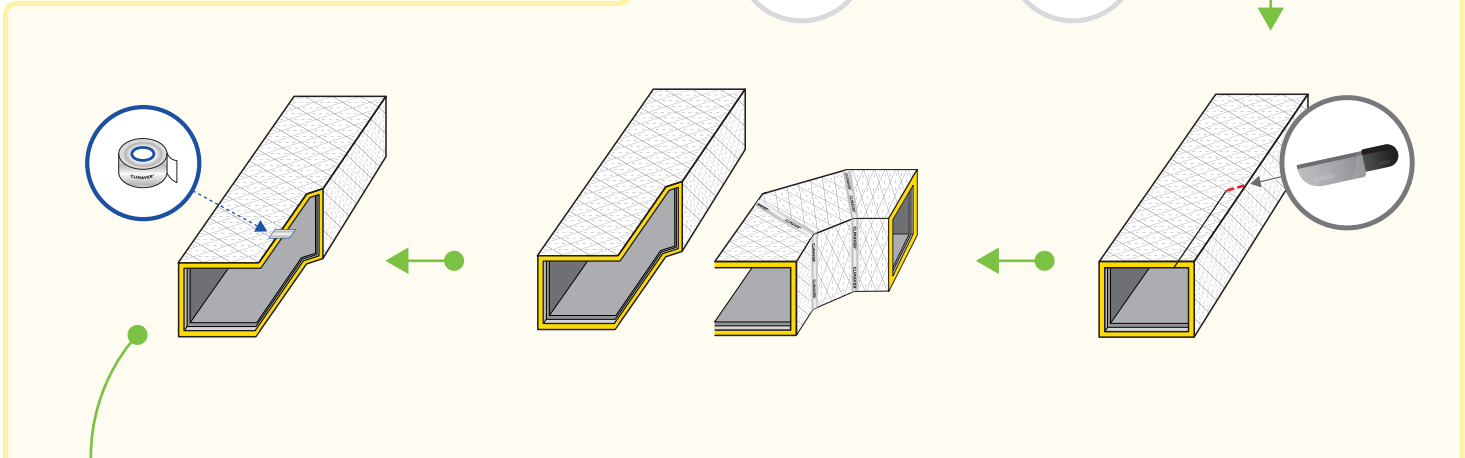
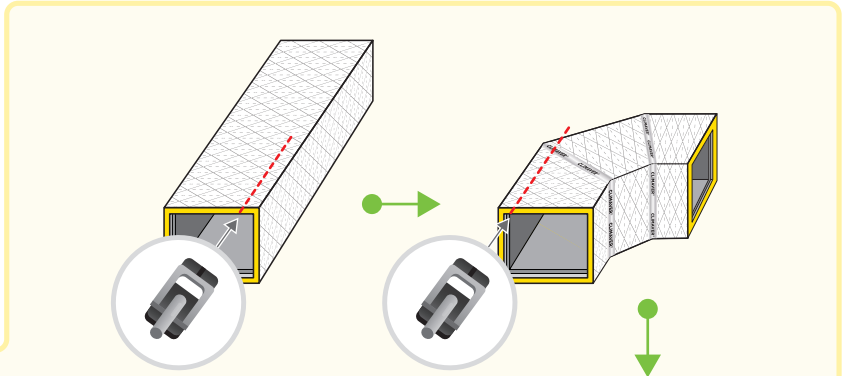
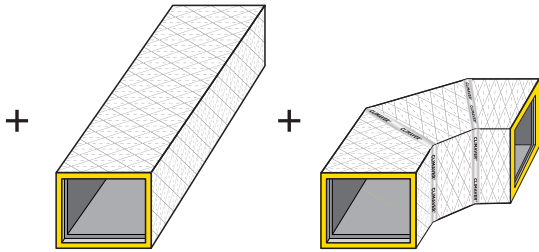

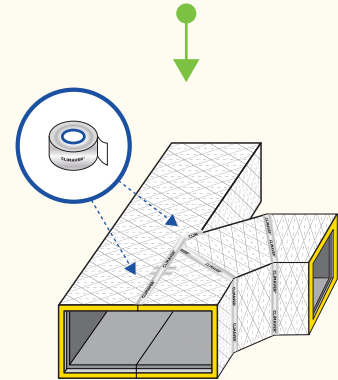
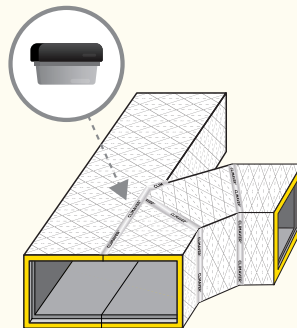
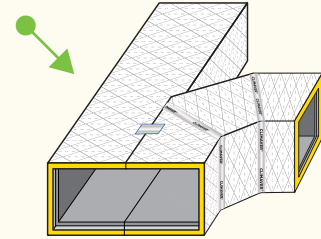
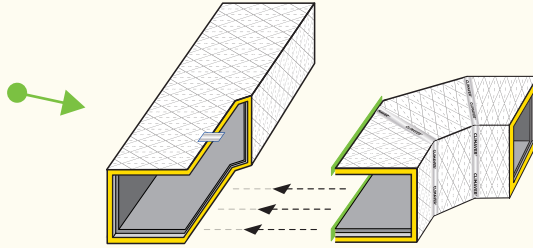
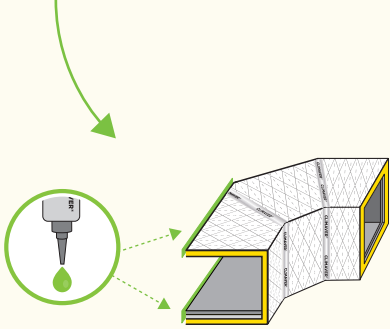

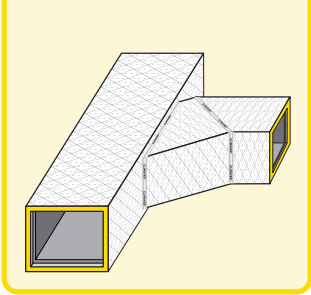

**ISOVER**  
SAINT-GOBAIN

**CLIMAVER®**

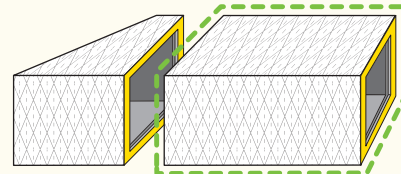
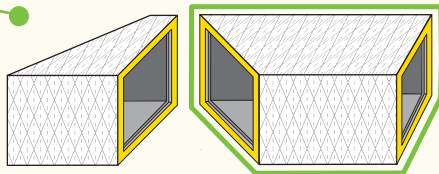
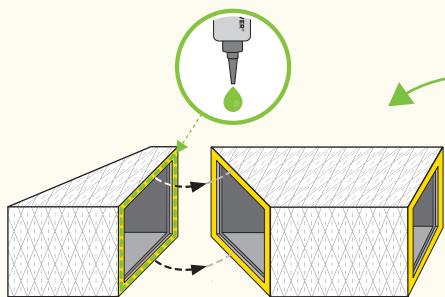
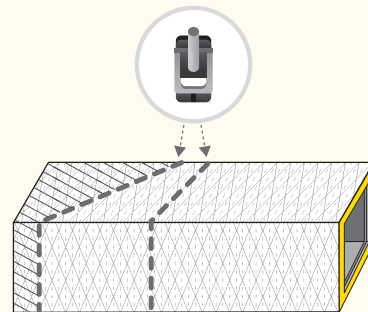
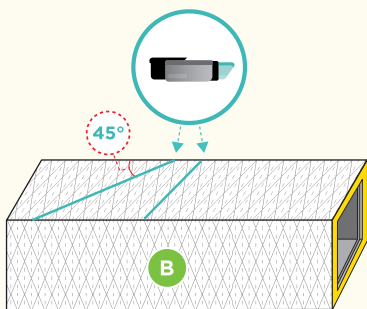
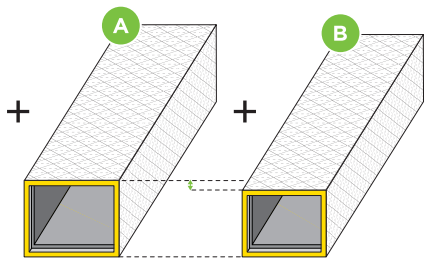

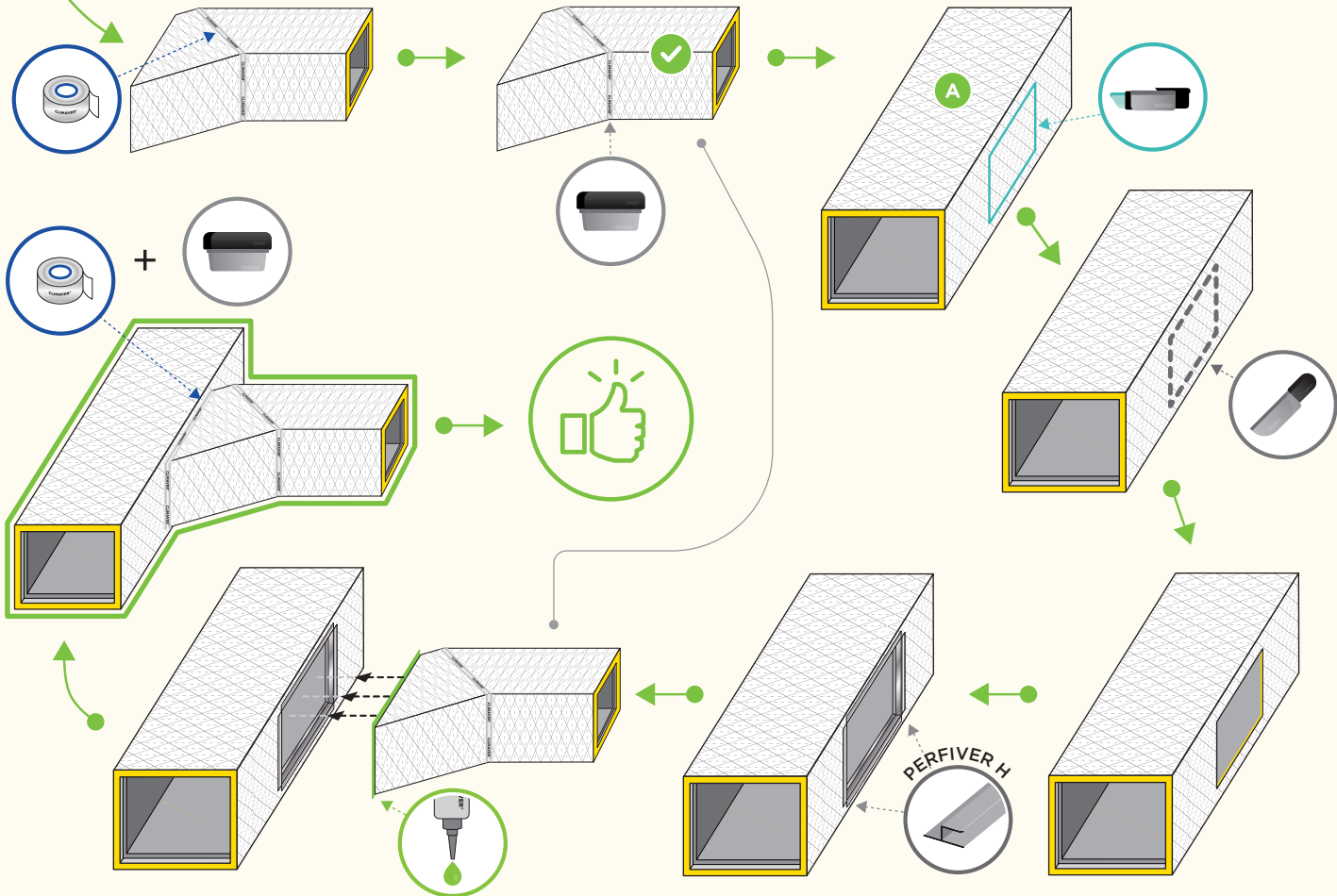

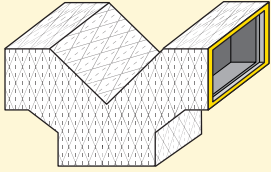

**ISOVER**  
SAINT-GOBAIN

**CLIMAVER®**

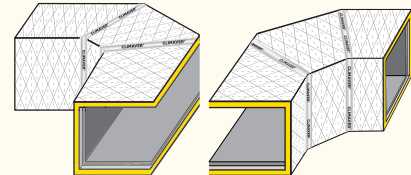
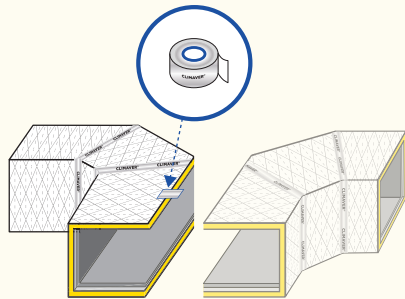
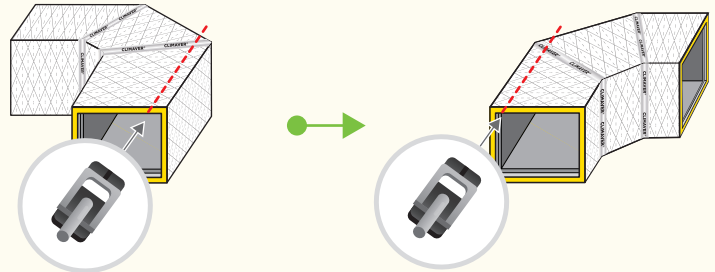
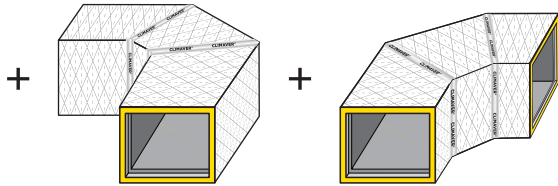
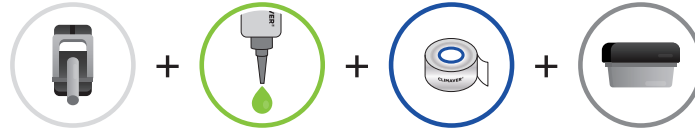

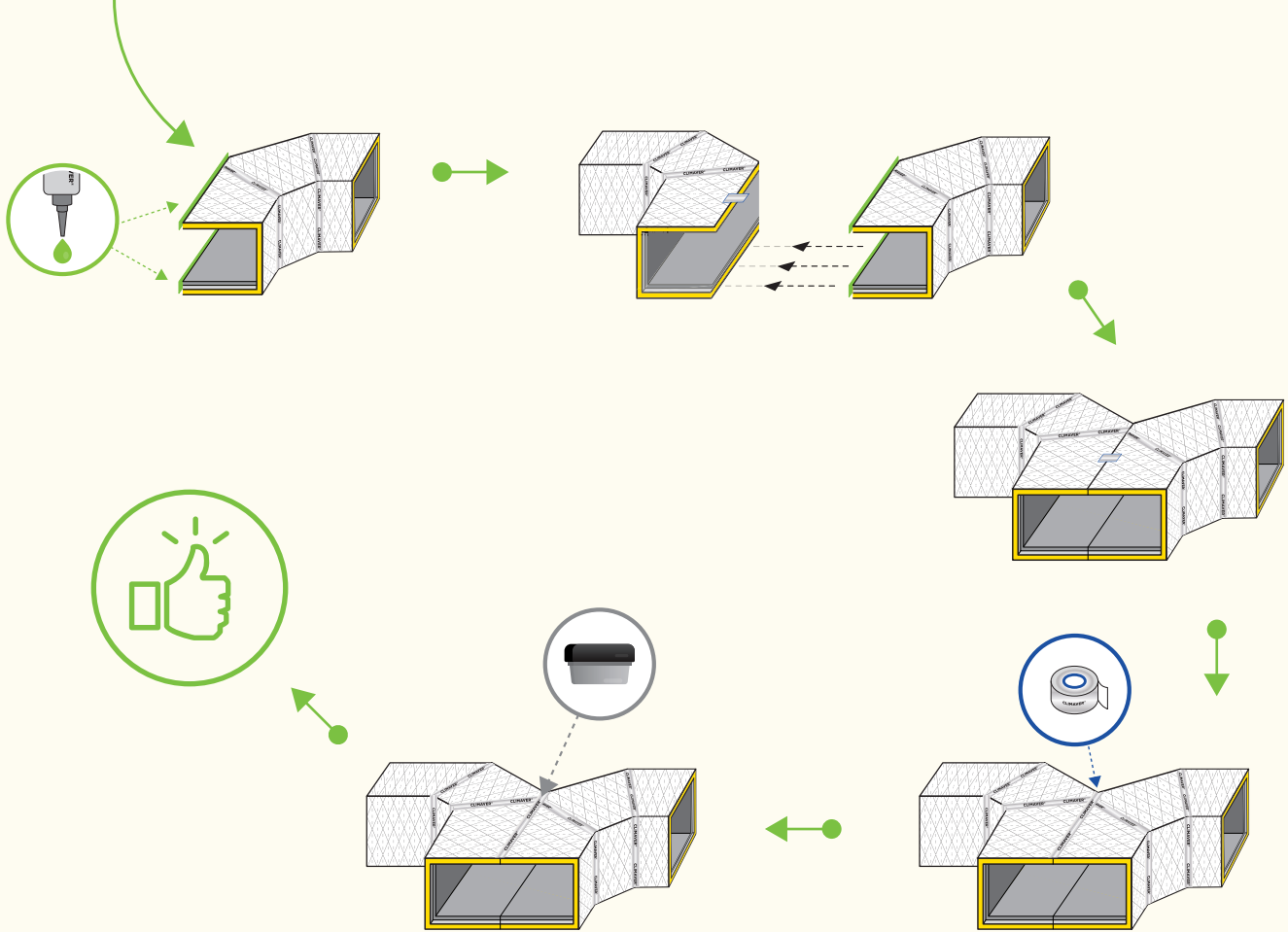

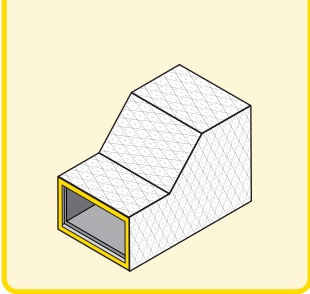

**ISOVER**  
SAINT-GOBAIN

**CLIMAVER®**

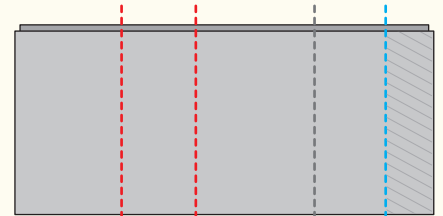
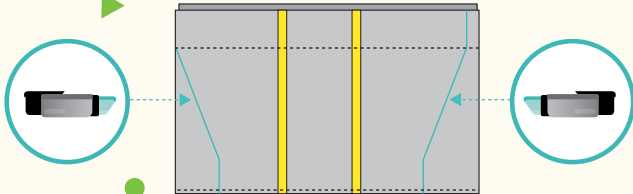
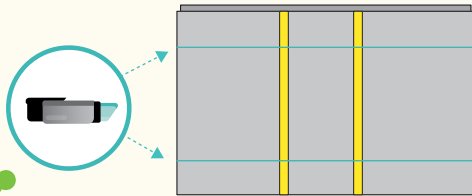
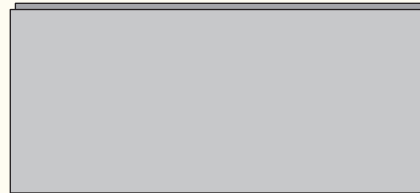
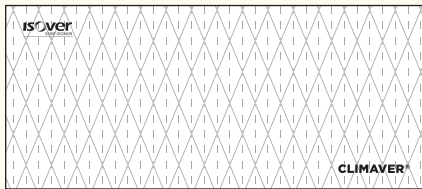

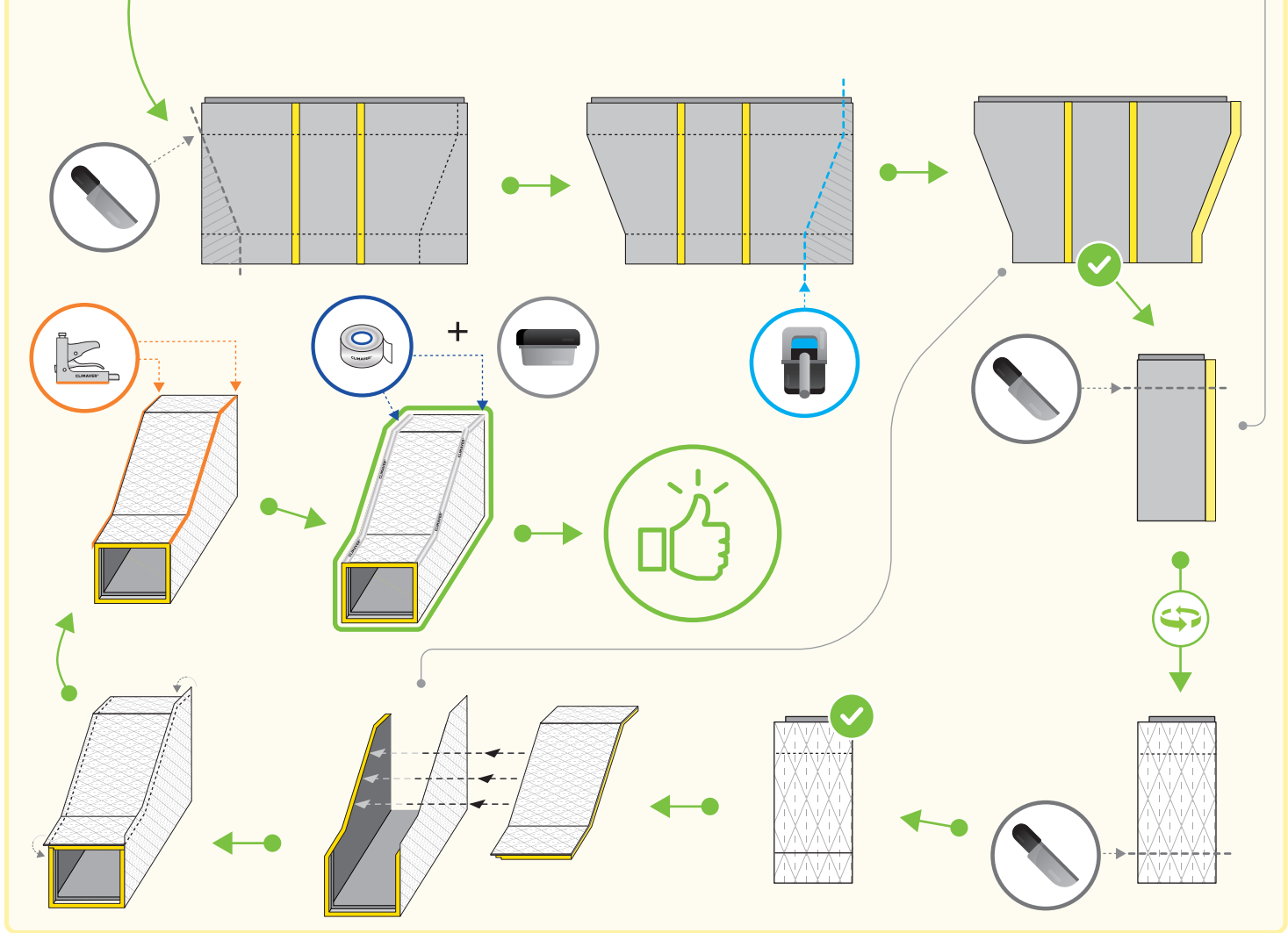



## VOS CONSEILLERS TECHNICO-COMMERCIAUX

### ÎLE DE FRANCE NORMANDIE-CENTRE

Serge SEBIRAN  
Tél. : 06 88 06 84 96  
serge.sebiran@saint-gobain.com

### OUEST ET SUD-EST

Sylvie POTIER  
Tél. : 06 74 93 76 68  
sylvie.potier@saint-gobain.com

### NORD-EST

Pierre-Loïc MAHIEU  
Tél. : 06 89 99 58 56  
pierre-loic.mahieu@saint-gobain.com

### SUD-EST

Gaël ESTRAGNAT  
Tél. : 06 32 50 33 94  
gael.estagnat@saint-gobain.com

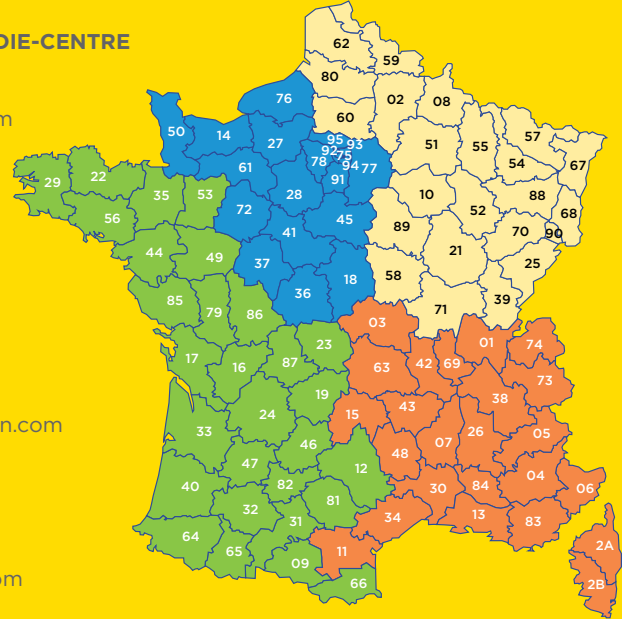

**Saint-Gobain Isover**  
**Tour Saint-Gobain**  
**12, place de l'Iris**  
**Tél. : +33 (0)1 88 54 00 00**

[www.isover.fr](http://www.isover.fr)  
[www.isover-marches-techniques.fr](http://www.isover-marches-techniques.fr)

## VOTRE FORMATEUR TECHNIQUE

Jérôme QUINIOU  
Tel. : 06 42 06 18 93  
jerome.quiniou@saint-gobain.com