

CLIMAVÉR[®] GUIDE D'INSTALLATION

Le système de conduit aéraulique pré-isolé

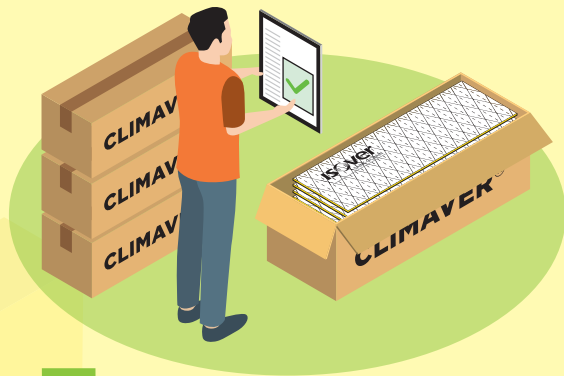

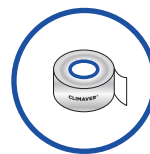

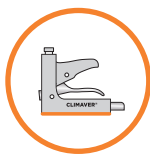
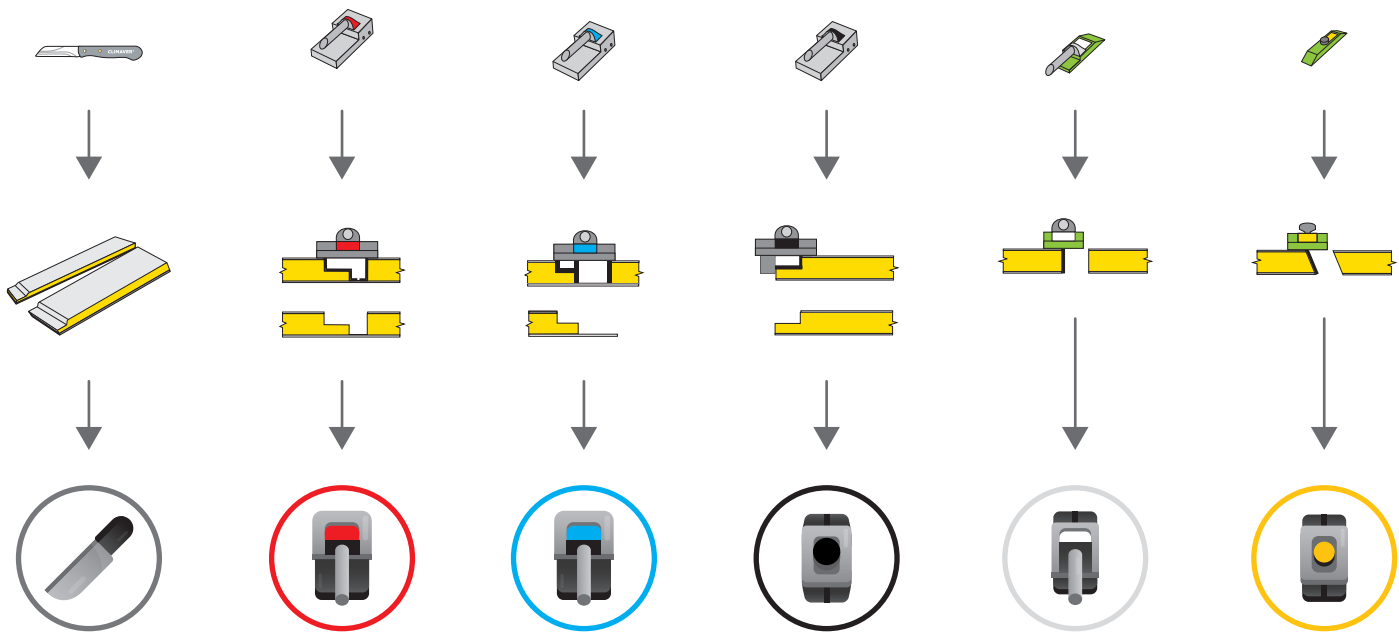

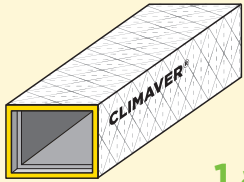

1.a

ISOVER
SAINT-GOBAIN

CLIMAVER®



1.a

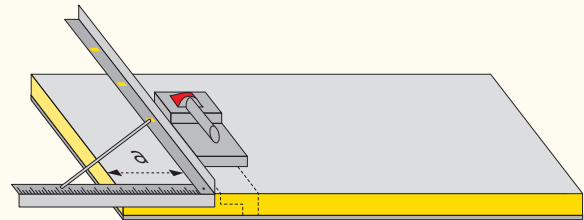
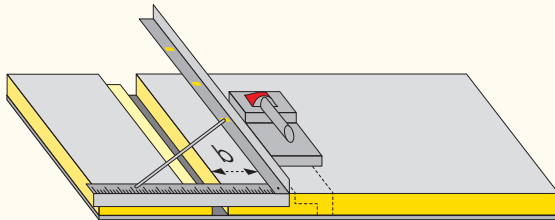
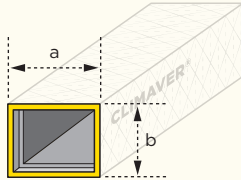

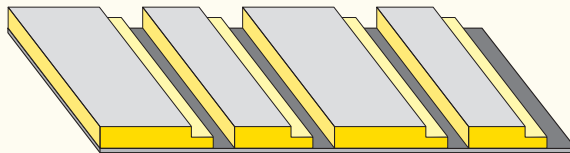
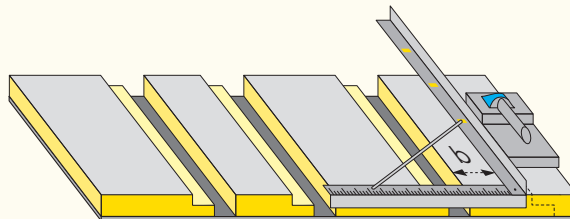
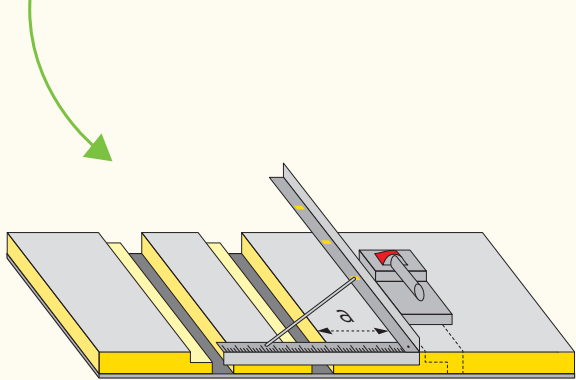

2

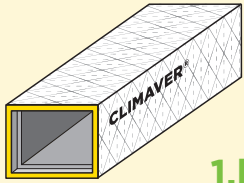

1.b

ISOVER
SAINT-GOBAIN

CLIMAVER®



1.b

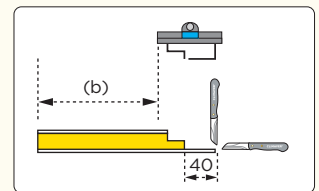
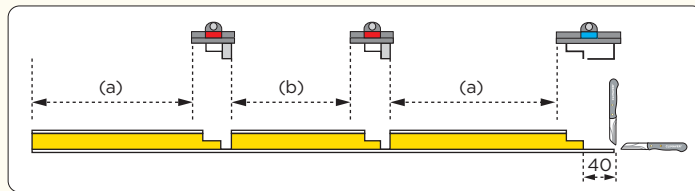
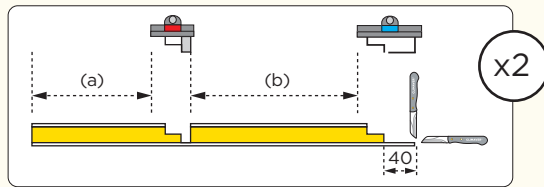
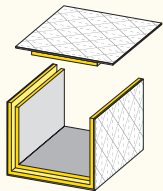
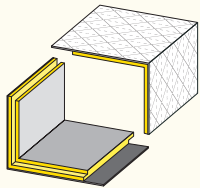
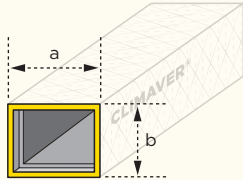

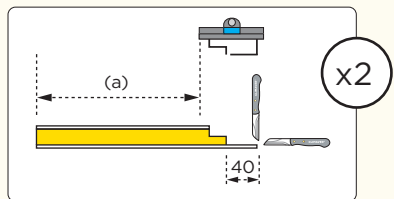
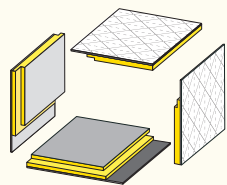

+

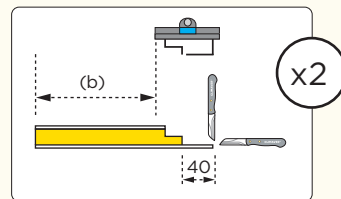

2

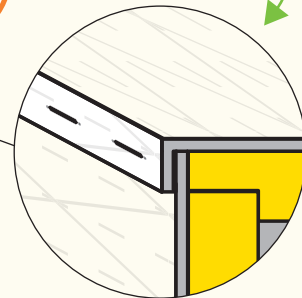
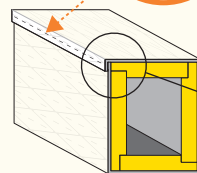
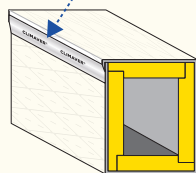
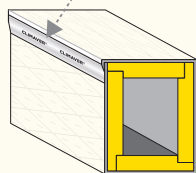
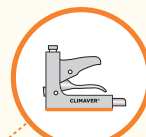
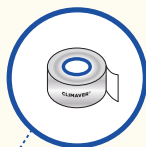
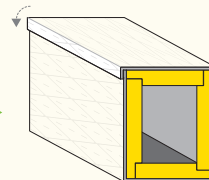
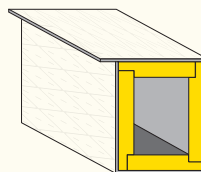
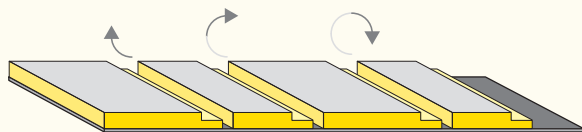

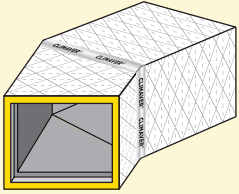

ISOVER
SAINT-GOBAIN

CLIMAVER®

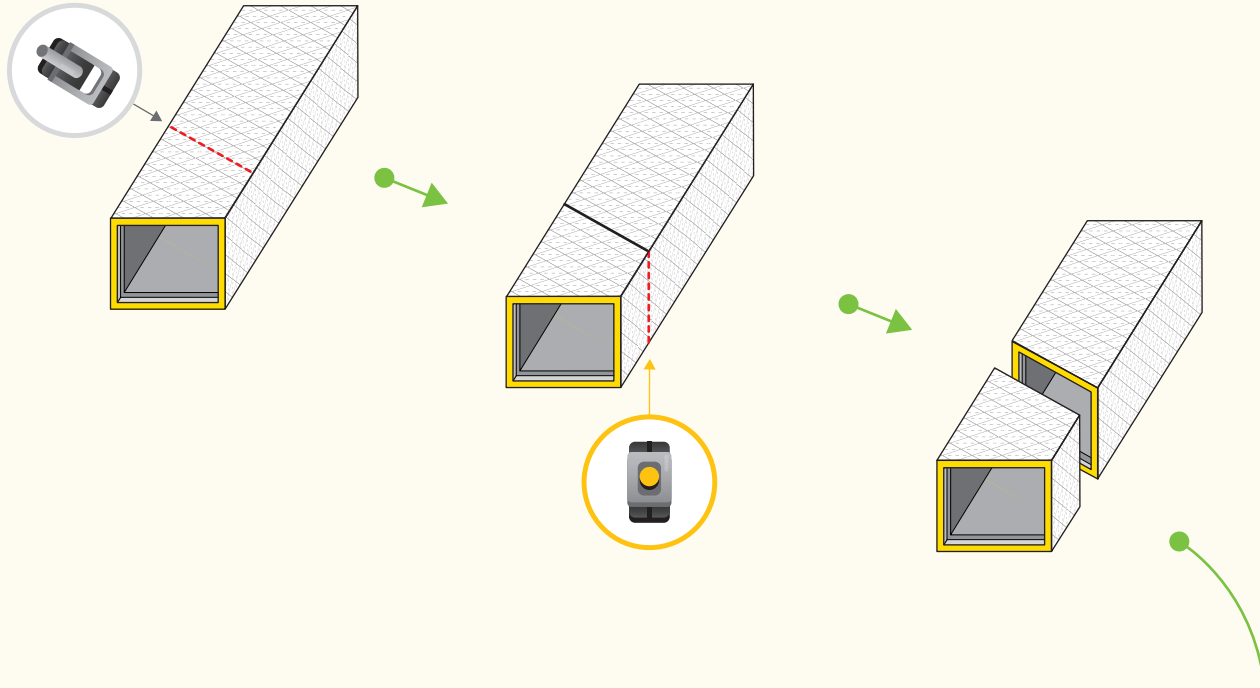

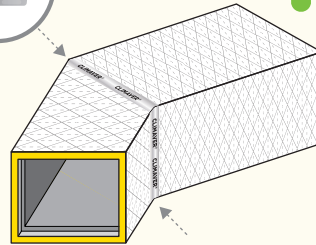
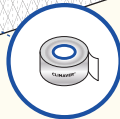
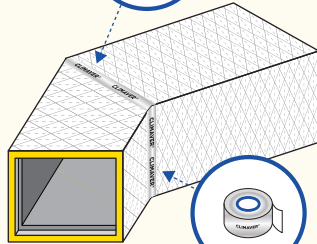
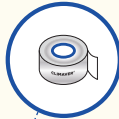
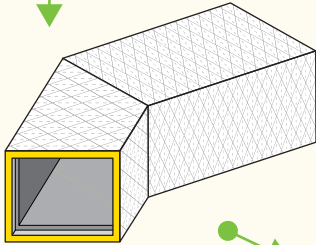
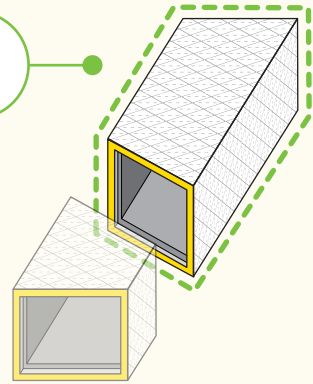
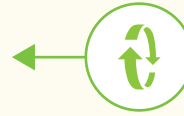
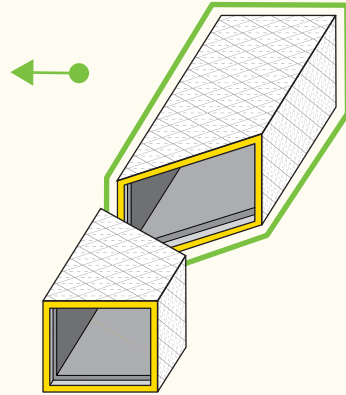
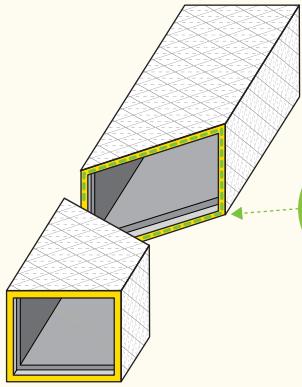

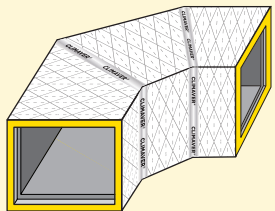

ISOVER
SAINT-GOBAIN

CLIMAVER®

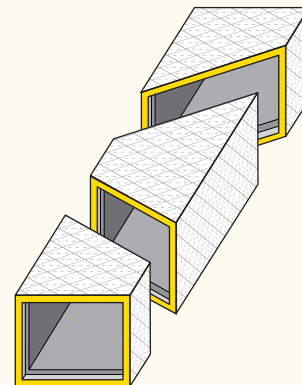
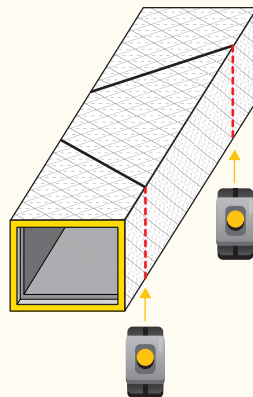
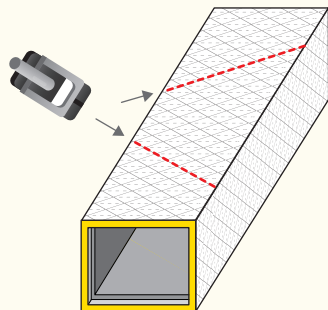

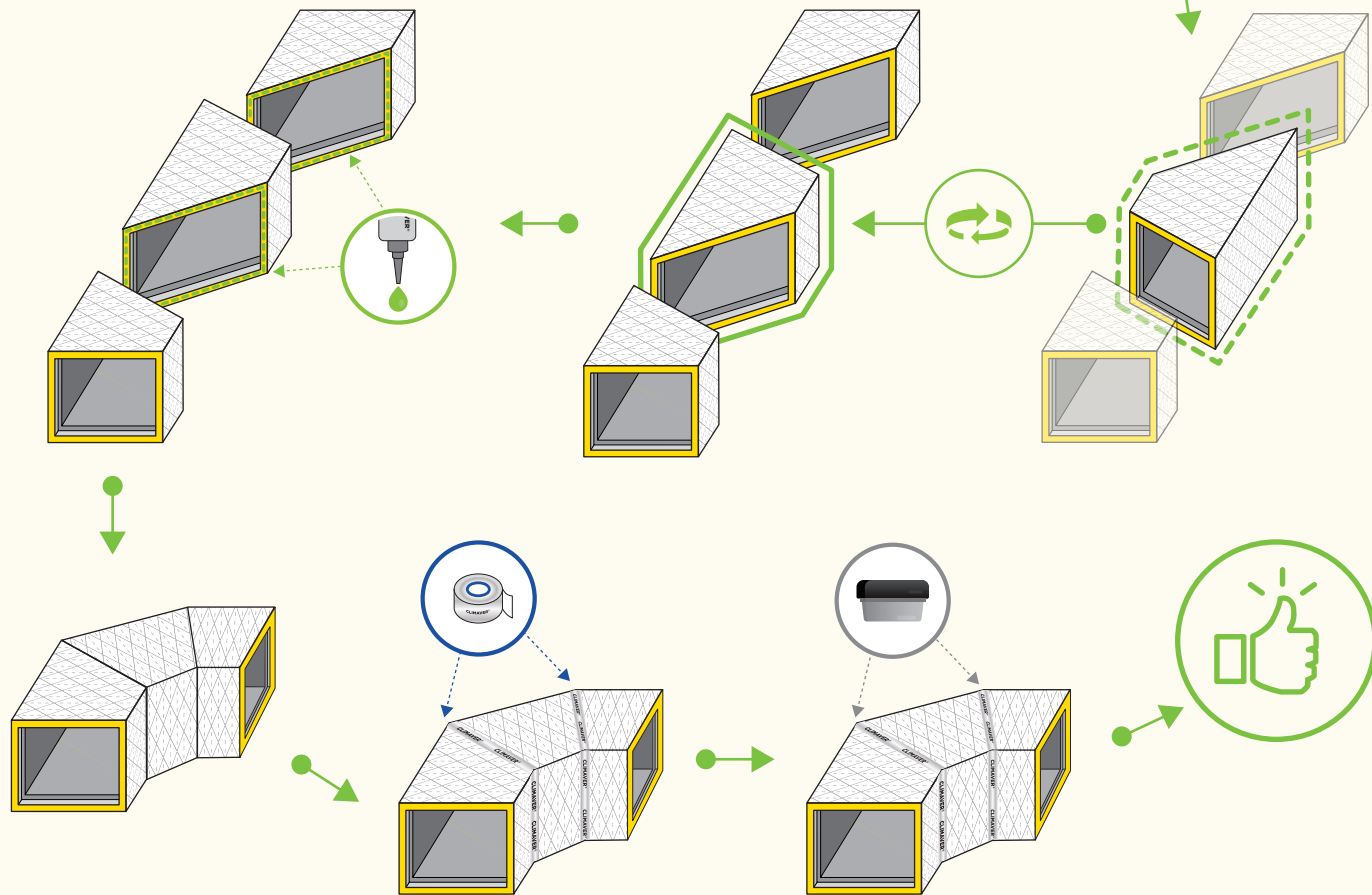

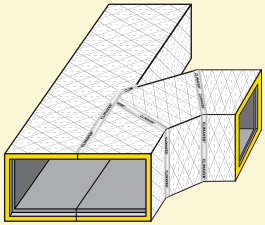

ISOVER
SAINT-GOBAIN

CLIMAVÉR®

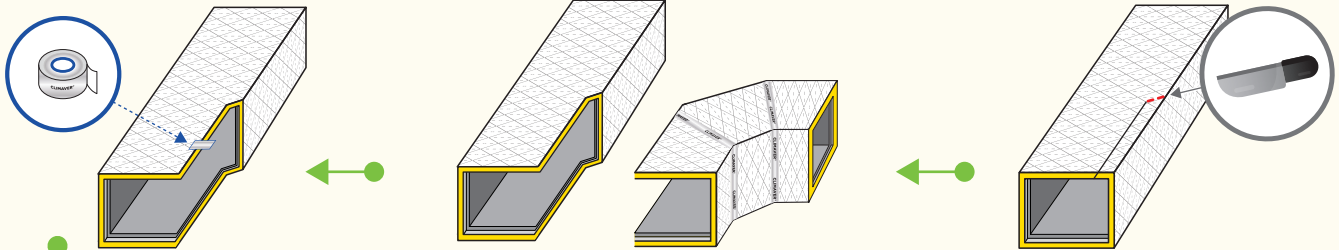
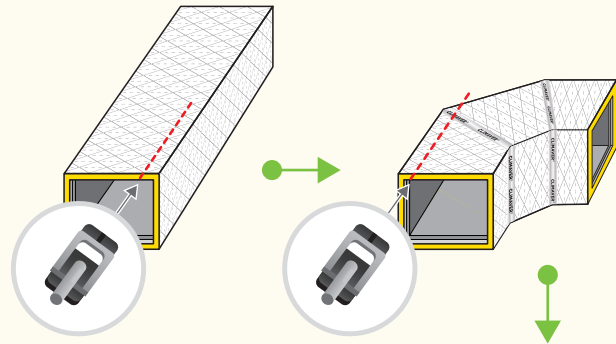
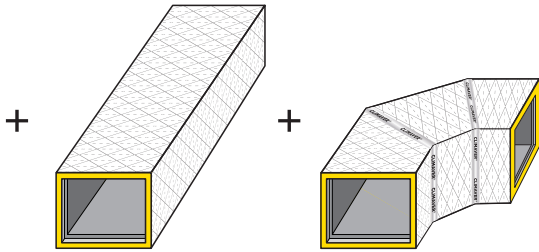

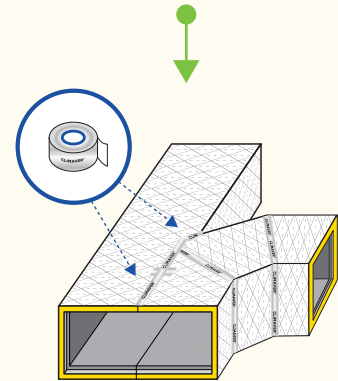
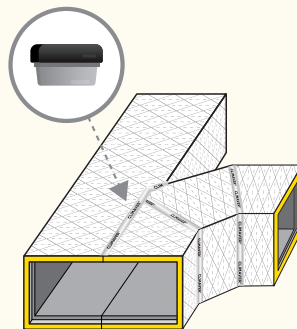
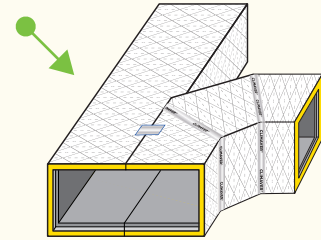
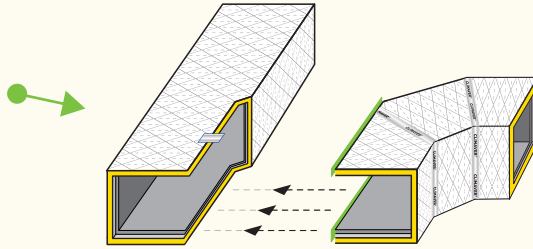
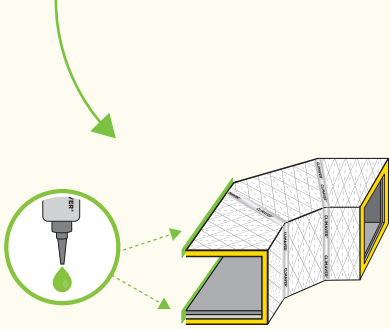

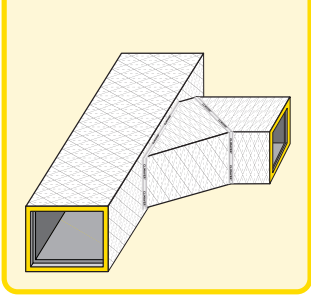

ISOVER
SAINT-GOBAIN

CLIMAVER®

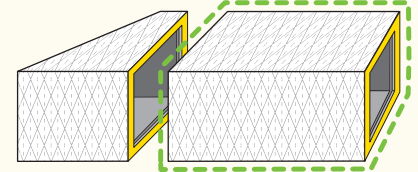
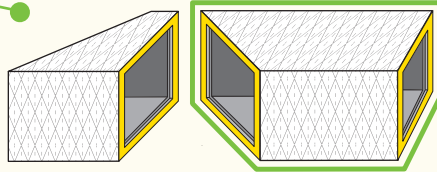
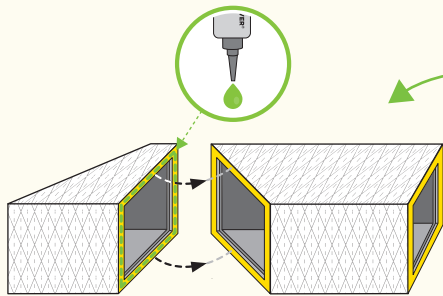
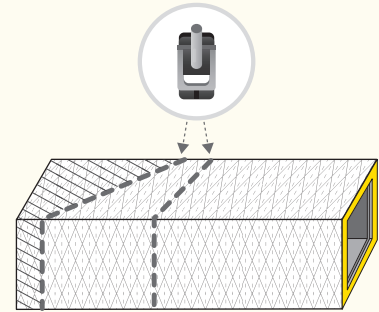
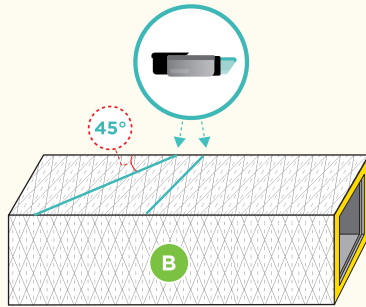
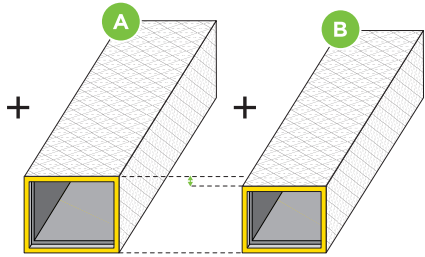

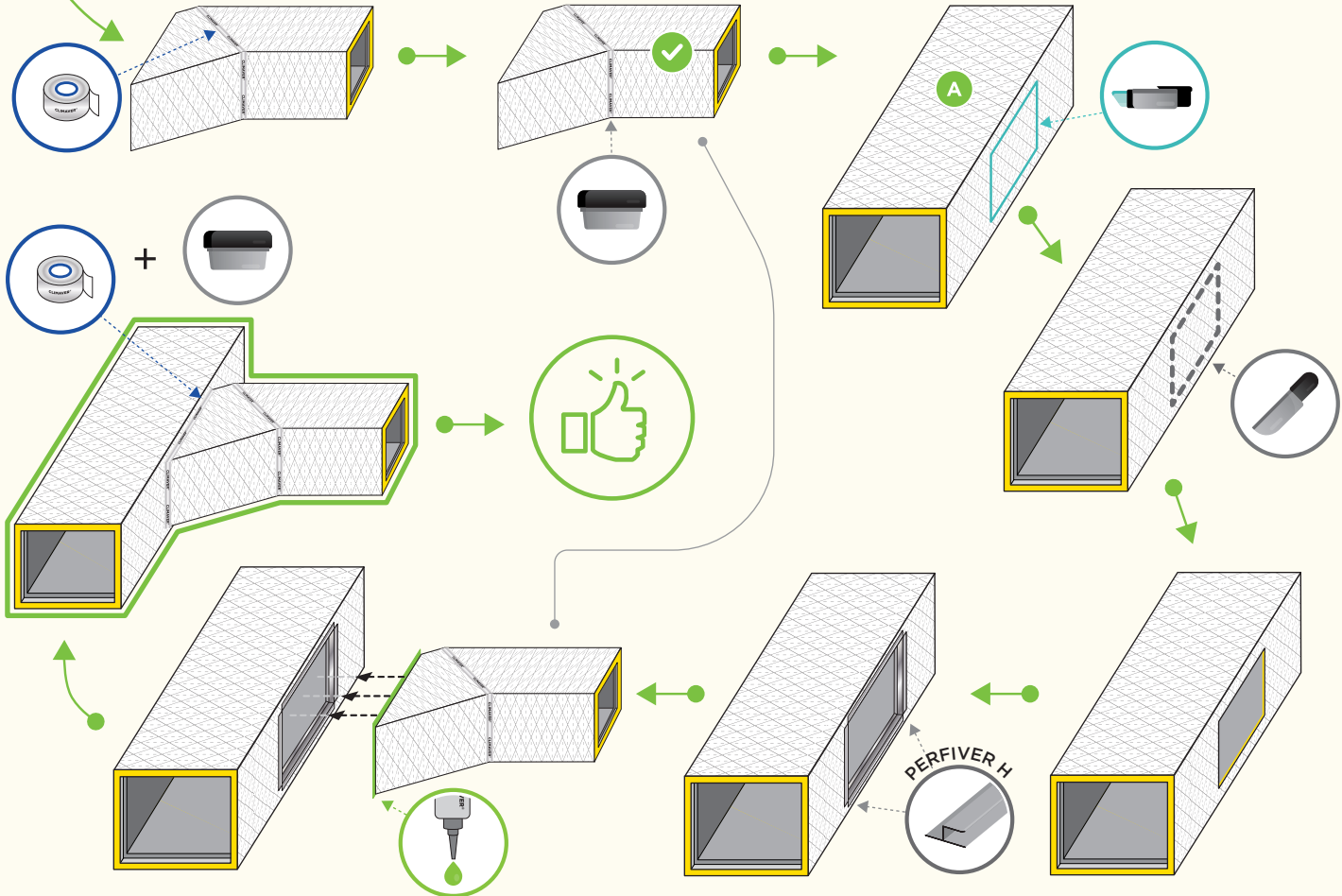

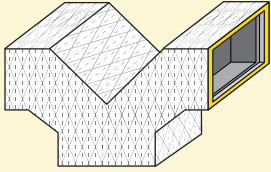

ISOVER
SAINT-GOBAIN

CLIMAVER®

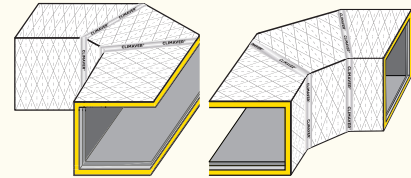
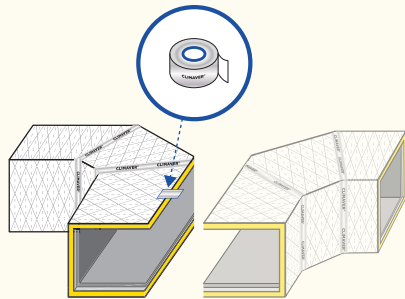
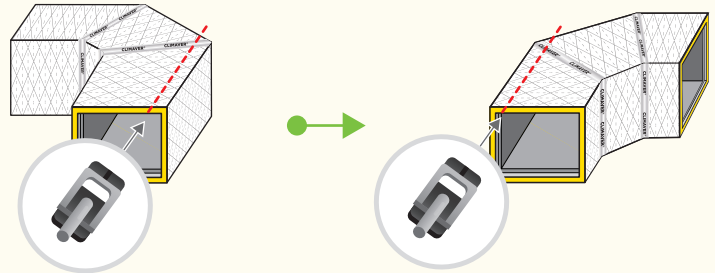
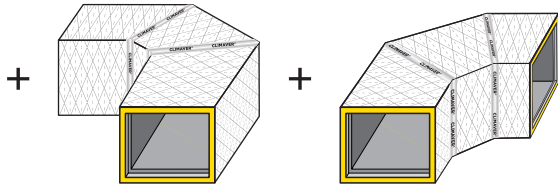
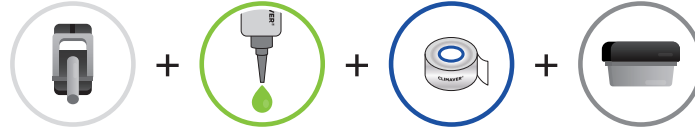

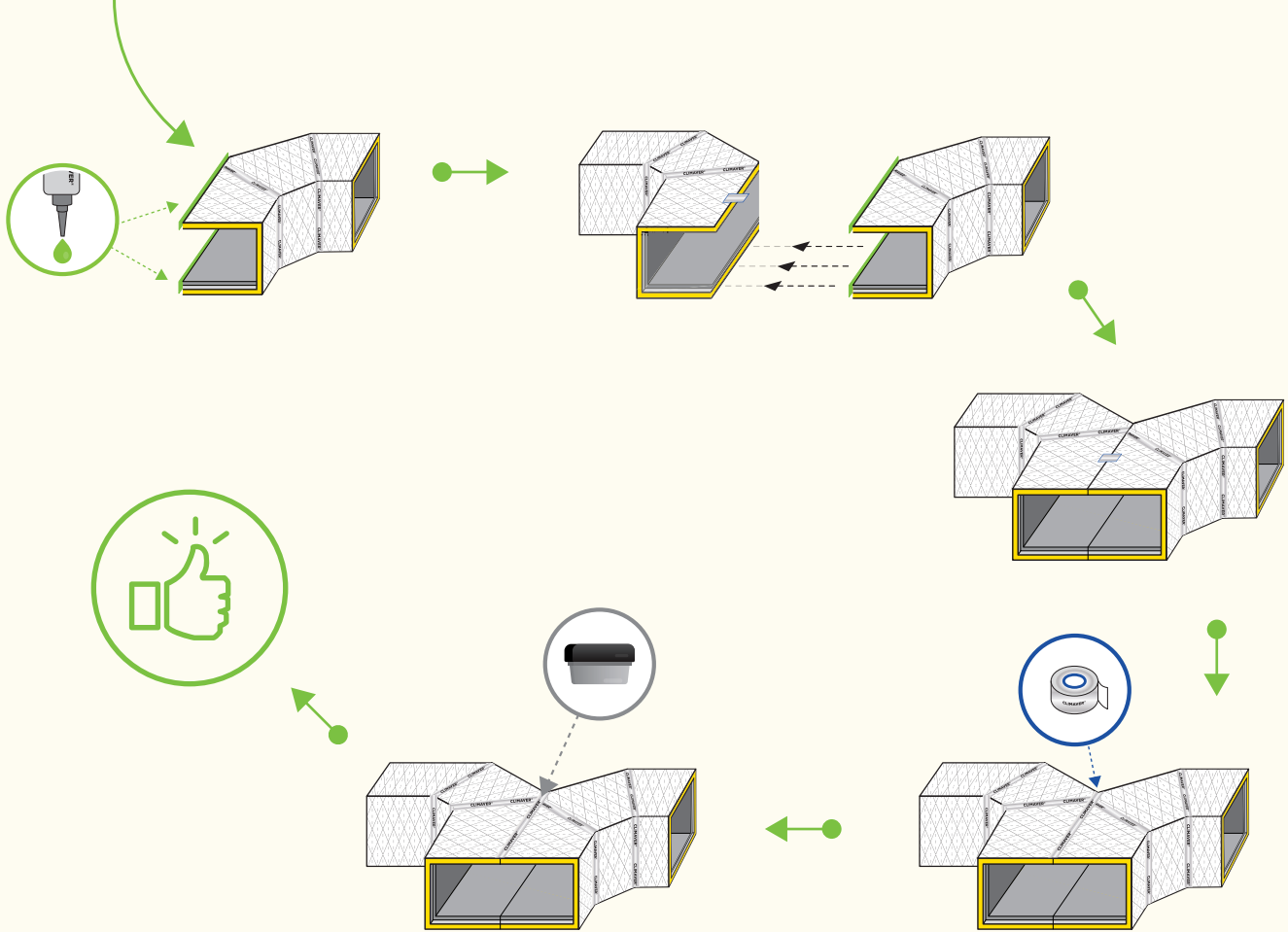

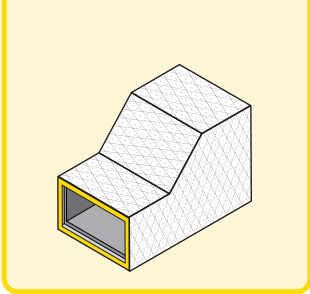

ISOVER
SAINT-GOBAIN

CLIMAVER®

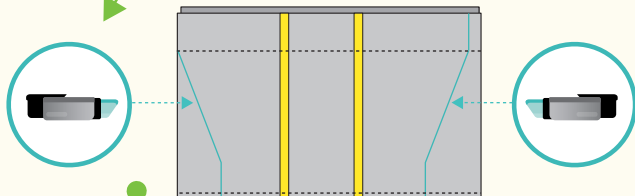
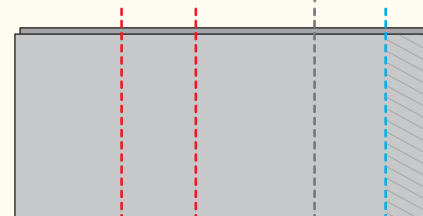
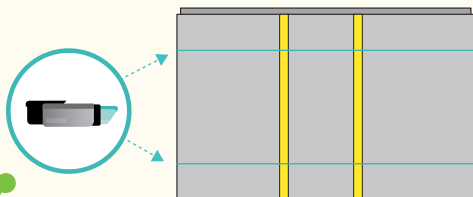
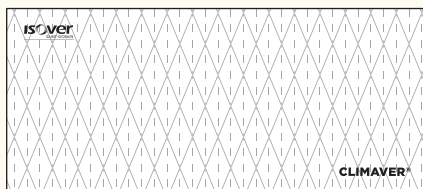

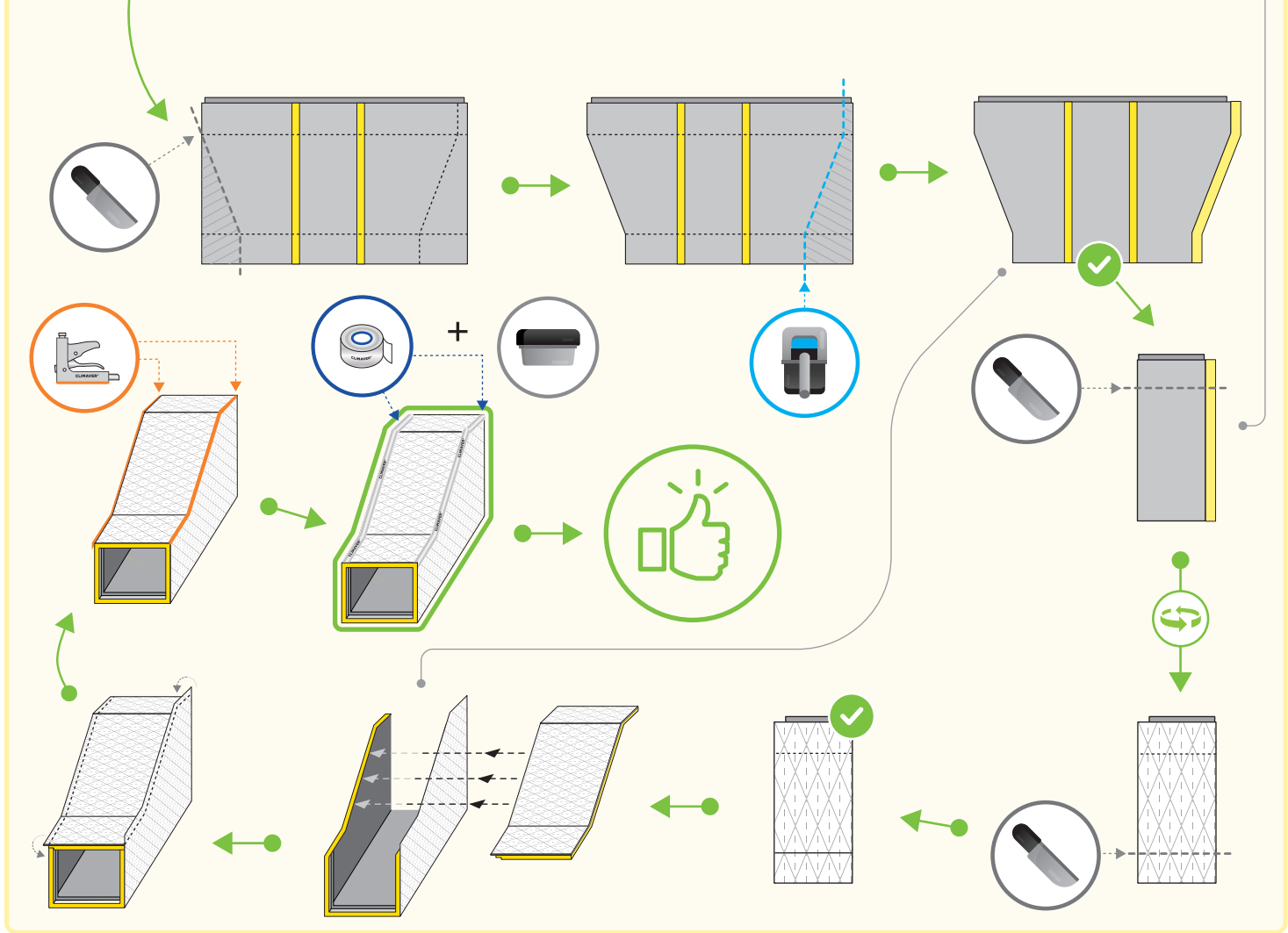



VOS CONSEILLERS TECHNICO-COMMERCIAUX

■ ÎLE DE FRANCE NORMANDIE-CENTRE

Serge SEBIRAN
Tél. : 06 88 06 84 96
serge.sebiran@saint-gobain.com

■ OUEST ET SUD-EST

Sylvie POTIER
Tél. : 06 74 93 76 68
sylvie.potier@saint-gobain.com

■ NORD-EST

Pierre-Loïc MAHIEU
Tél. : 06 89 99 58 56
pierre-loic.mahieu@saint-gobain.com

■ SUD-EST

Gaël ESTRAGNAT
Tél. : 06 32 50 33 94
gael.estagnat@saint-gobain.com

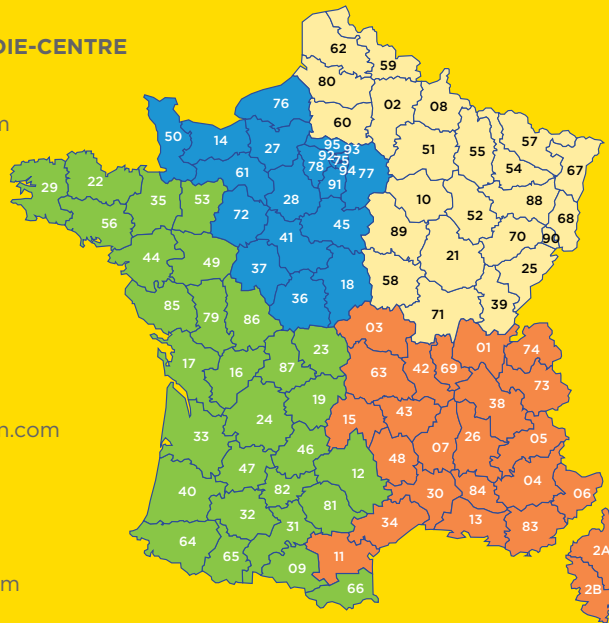

Saint-Gobain ISOVER

1, rue Gardénat Lastopol
92282 Suresnes Cedex
France
Tél. : +33 (0)1 40 99 24 00
Fax : +33 (0)1 41 44 81 40

www.isover.fr
www.isover-marches-techniques.fr

VOTRE FORMATEUR TECHNIQUE

Jérôme QUINIOU
Tél. : 06 42 06 18 93
jerome.quiniou@saint-gobain.com